

BenQ

PB8260 Digital Projector

Installation Series

User's Manual

Welcome

Copyright

Copyright 2005 by BenQ Corporation. All rights reserved. No part of this publication may be reproduced, transmitted, transcribed, stored in a retrieval system or translated into any language or computer language, in any form or by any means, electronic, mechanical, magnetic, optical, chemical, manual or otherwise, without the prior written permission of BenQ Corporation.

Disclaimer

BenQ Corporation makes no representations or warranties, either expressed or implied, with respect to the contents hereof and specifically disclaims any warranties, merchantability or fitness for any particular purpose. Further, BenQ Corporation reserves the right to revise this publication and to make changes from time to time in the contents hereof without obligation to notify any person of such revision or changes.

*DLP, Digital Micromirror Device and DMD are trademarks of Texas Instruments. Others are copyrights of their respective companies or organizations.

Table of contents

Important safety instructions	1
Introduction	5
Projector features	5
Shipping contents	6
Projector exterior view	7
Controls and functions	9
Positioning your projector	13
Choosing a location	13
Obtaining a preferred projected image size	14
Connection	16
Wireless connection	16
Cable connections	16
Operation	19
Start up	19
Preparing for a wireless presentation	20
Switching input signals	20
Adjusting the image	21
Optimizing the image	23
Laser pointer operation	24
Using the remote mouse functions	24
PIP (Picture In Picture) operation	25
Freezing the image	26
Adjusting the volume	26
Hiding the image	26
Shutdown	27
Menu operation	28
Maintenance	36
Lamp information	38
Service information	43

Troubleshooting.....	44
Common problems & solutions	44
Specifications.....	45
Projector specifications	45
Dimensions	46
Timing chart	46
Warranty.....	48
Limited warranty	48
Regulatory statements.....	49
FCC statement	49
EEC statement	49
MIC statement	49

1 Important safety instructions

Your BenQ projector is designed and tested to meet the latest standards for safety of information technology equipment. However, to ensure safe use of this product, it is important that you follow the instructions mentioned in this manual and marked on the product.

Caution

- **To prevent shock, do not open the cabinet.** There are no user-serviceable parts inside.

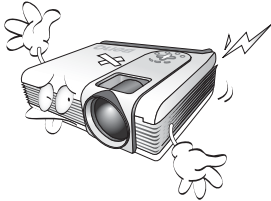

- **Please read this user's manual before you operate your projector.** Save this user's manual for future reference.

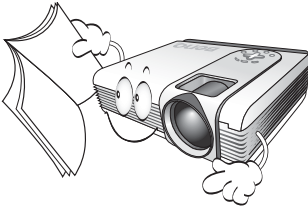

- **Do not look straight at the projector lens during operation.** The intense light beam may damage your eyes.

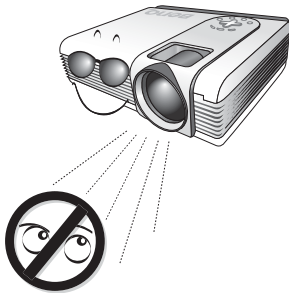

- **Refer servicing to qualified service personnel.**

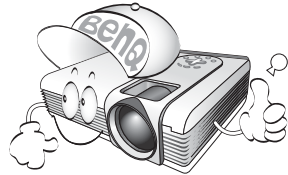

- **Always open the lens shutter or remove the lens cap when the projector lamp is on.**



- In some countries, the line voltage is NOT stable. This projector is designed to operate safely within a mains voltage of 100 to 240 volts, but could fail if power cuts or surges of ± 10 volts occur. **In areas where the mains voltage may fluctuate or cut out, it is recommended that you connect your projector through a power stabilizer, surge protector or uninterruptible power supply (UPS).**

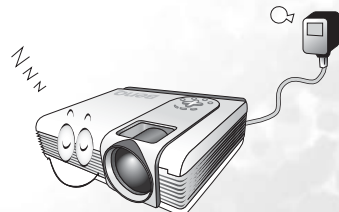

Safety Instructions

1. The lamp becomes extremely hot during operation. Allow the projector to cool for approximately 45 minutes prior to removing the lamp assembly for replacement.

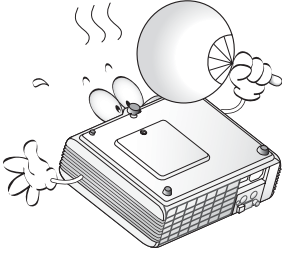

2. Do not operate lamps beyond the rated lamp life. Excessive operation of lamps beyond the rated life could cause them to explode on rare occasions.

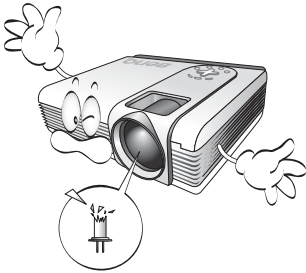

3. Never replace the lamp assembly or any electronic components unless the projector is unplugged.

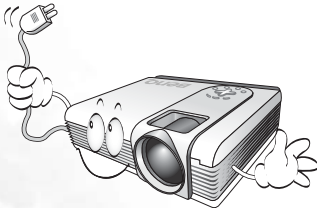

4. Do not place this product on an unstable cart, stand, or table. The product may fall, sustaining serious damage.

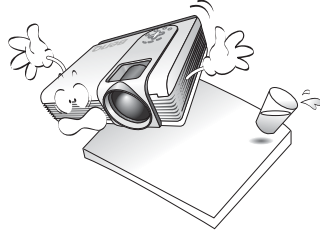

5. To reduce the risk of electric shock, do not disassemble this appliance. Take it to a qualified technician when service or repair is required. Incorrect reassembly can cause malfunction of the projector or electric shock when the appliance is subsequently used.

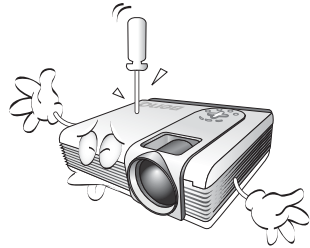

6. This product is capable of displaying inverted images for ceiling mount installation. Please use BenQ's Ceiling Mounting Kit for mounting the unit and ensure it is securely installed.

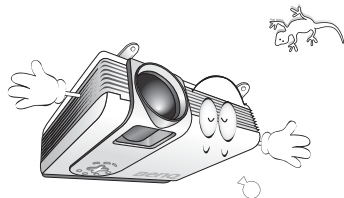

Safety Instructions (Continued)

7. Do not place this projector in any of the following environments.
- Space that is poorly ventilated or confined. Allow at least 50 cm clearance from walls and free flow of air around the projector.
 - Locations where temperatures may become excessively high, such as the inside of a car with all windows rolled up.
 - Locations where excessive humidity, dust, or cigarette smoke may contaminate optical components, shortening the projector's life span and darkening the image.



- Locations near fire alarms
- Locations with an ambient temperature above 40°C / 104°F
- Locations where the altitudes are higher than 10000 feet.

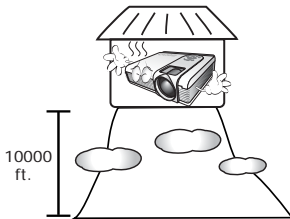

8. Do not block the ventilation holes.
- Do not place this unit on a blanket, bedding or any other soft surface.
 - Do not cover this unit with a cloth or any other item.
 - Do not place inflammables near the projector.



If the ventilation holes are seriously obstructed, overheating inside the unit may result in a fire.

9. Always place the unit on a level, horizontal surface during operation.
- Do not use if tilted at an angle of more than 10 degrees left to right, nor at angle of more than 15 degrees front to back. Using the unit when it is not fully horizontal may cause a malfunction of, or damage to, the lamp.

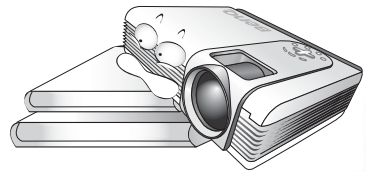

10. Do not stand the unit on end vertically.

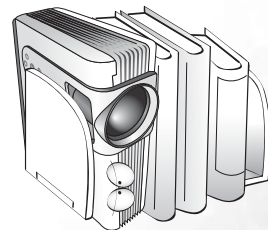

Doing so may cause the unit to fall over, causing injury or resulting in damage to the unit.

Safety Instructions (Continued)

11. Do not step on the projector or place any objects upon it.

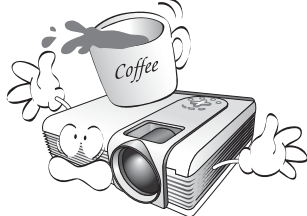

Besides probable physical damage to the projector, doing so may result in accidents and possible injury.

12. Do not block the projection lens with any objects when the projector is under operation as this could cause the objects become deformed or even cause a fire. To temporarily turn off the lamp, press **Blank** on the projector or remote control.

13. Do not place liquids near or on the projector. Liquids spilled into the projector may cause it to fail. If the projector does become wet, disconnect it from the power supply's wall socket and call BenQ to have the projector serviced.

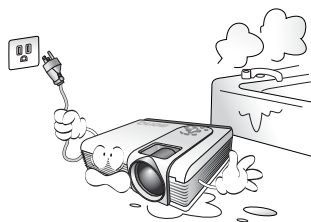

2 Introduction

Projector features

The projector integrates high-performance optical engine projection and a user-friendly design to deliver high reliability and ease of use.

The projector offers the following features:

- Making wireless connection with your laptop
- Full-function remote control with laser pointer/ remote mouse function
- High quality manual zoom lens
- One-key auto-adjustment to display the best picture quality
- Digital keystone correction to correct distorted images
- Adjustable color balance control for data/video display
- Ultra-high brightness
- Ability to display 16.7 million colors
- On-screen menus in 10 languages: English, French, German, Italian, Spanish, Russian, Traditional Chinese, Simplified Chinese, Japanese, and Korean.
- Switchable Normal/ Economic mode to reduce the power consumption
- Powerful AV function to provide high quality AV picture
- HDTV compatibility (YPbPr)
- Two PC input terminals and one PC output terminal
- Replaceable dust filters

 **The brightness of the projected image will vary depending on the ambient lighting conditions and contrast/brightness settings.**

 **The lamp brightness will decline over time and may vary within the lamp manufacturers specifications. This is normal and expected behavior.**

Shipping contents

The projector is shipped with the cables required for connection to a PC and to video equipment. Carefully unpack and verify that you have all of the items shown below. If any of these items are missing, please contact your place of purchase.

 **The supplied accessories will be suitable for your region, and may differ from the illustrated.**



Projector



Soft Carry Case



Wireless Card



Warranty Card



 **This CD is attached to the inside cover of the Wireless Navigator User's Manual.**



Wireless Navigator User's Manual and Wireless Navigator Installation CD



User's Manual



User's Manual CD



Quick Start Guide



Remote Control



Batteries



VGA-Component Cable



RCA Audio/Video Cable



VGA Cable



PC Audio Cable



USB Cable



D-Sub - DVI Cable



Power Cord

Optional accessories

1. Macintosh adaptor
2. 250W / 300W lamp module
3. Ceiling mount kit
4. Wireless Pro
5. Presentation Pro
6. DVI-I cable
7. S-Video cable
8. Dust filter
9. 3-2 power adaptor

Projector exterior view

Front / upper view

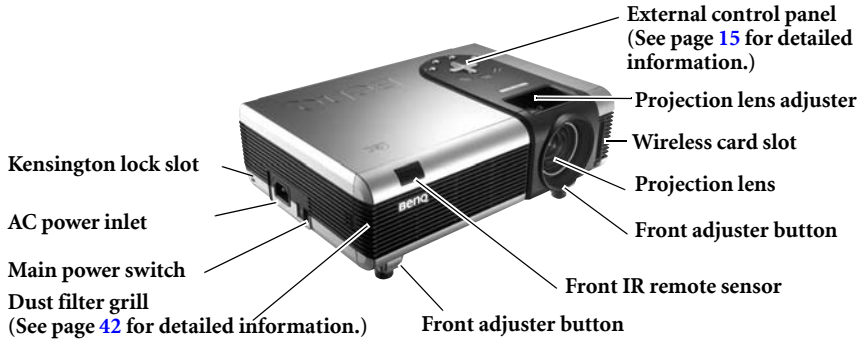

Back view

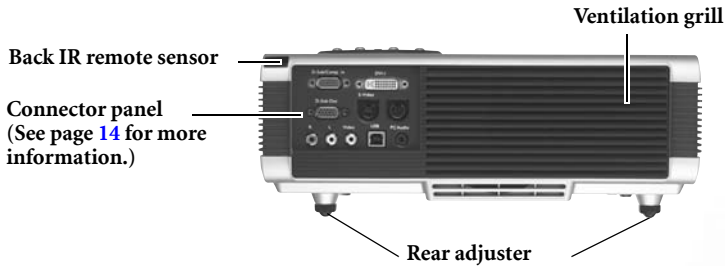

Bottom view

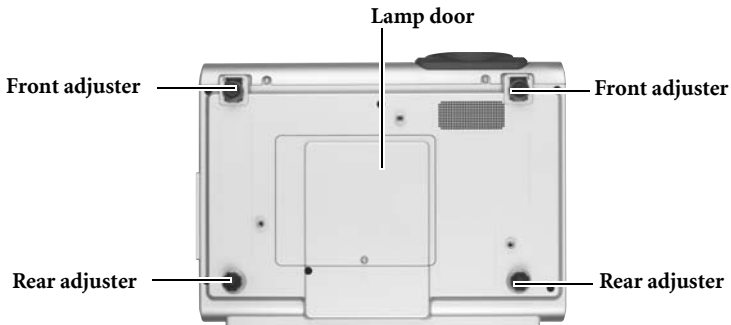

Connector panel

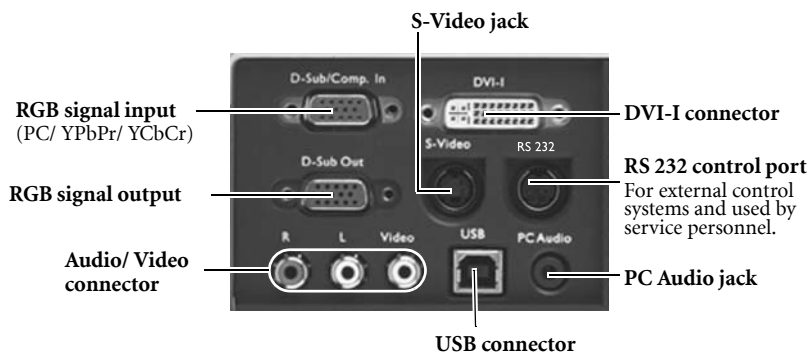

Controls and functions

External control panel

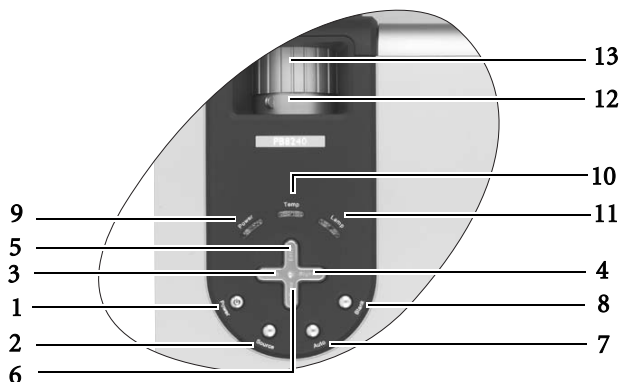

- 1. Power (Refer to page 25 for more information.)**
Turns the projector on or off.
- 2. Source (Refer to page 26 for more information.)**
Sequentially selects the input signal RGB, DVI, YPbPr, S-Video, or Video.
- 3. ◀ Left**
- 4. Right ▶**
When the on-screen menu is not activated, #3 and #4 function as **Keystone -/+** hot keys.
Refer to page 32 for more information.
- 5. ^ Exit**
Exits and saves the menu settings.
- 6. ▼ Menu**
Turns the on-screen display control menu on.
When the on-screen menu is activated, the #3 to #6 buttons are used as directional arrows to select the desired menu items and to make adjustments.
Refer to page 35 for more information.
- 7. Auto (Refer to page 27 for more information.)**
Automatically determines the best picture timings for the displayed image.
- 8. Blank (Refer to page 32 for more information.)**
Used to hide the screen image. You can press **Blank** again or **Return** to bring the image back.
- 9. Power indicator light**
Lights up or flashes when the projector is under operation.
- 10. Temperature warning light (Refer to page 46 for more information.)**
Flashes red if the projector's temperature becomes too high.
- 11. Lamp indicator light (Refer to page 44 for more information.)**
Indicates the status of the lamp. Lights up or flashes when the lamp has developed a problem.
- 12. Zoom ring**
Adjusts the size of the image.
- 13. Focus ring**
Adjusts the focus of the projected image.

Remote control description

Front view

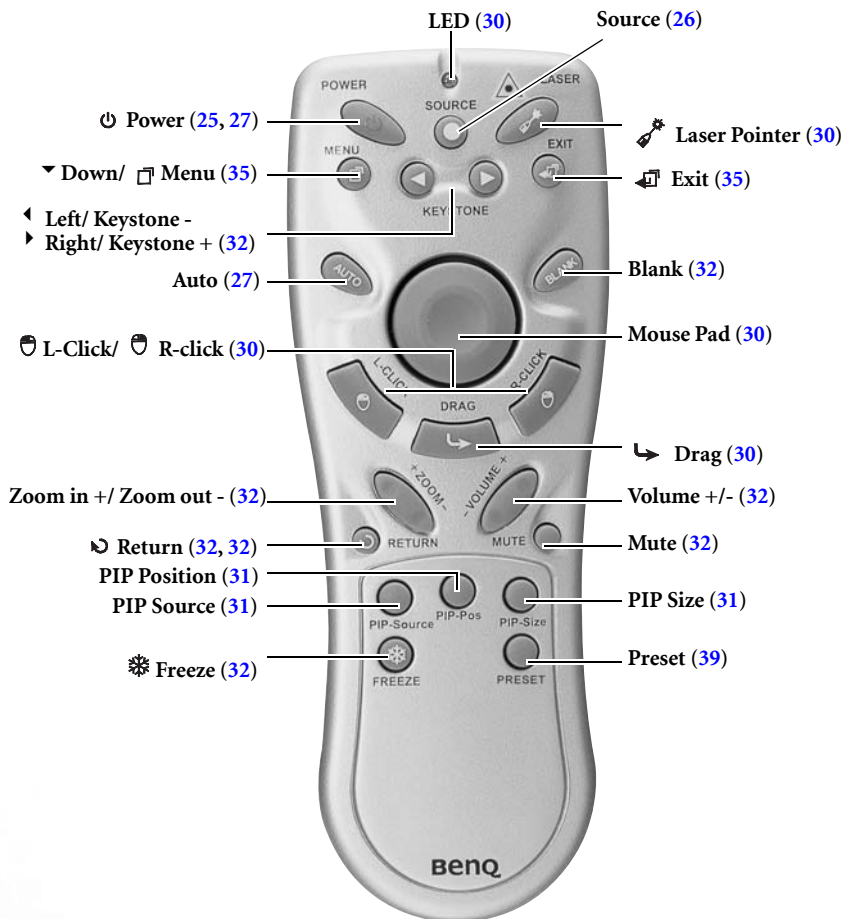

Notes on Remote Control Operation:

- Make sure that there are no obstacles between the remote control and the IR sensors on the projector that might obstruct the infra-red beam.
- If the remote control stops working, or if its effective range decreases, replace the batteries with new ones.
- The remote control may not work whilst the infrared remote sensor is directly exposed to bright sunlight or fluorescent lighting.
- In rare cases (like excessive humidity or smoke), ambient conditions could impede the operation of the remote control. If this happens, point the remote control at the main unit again, and repeat the operation.

Remote control effective range

Infra Red (IR) remote control sensors are located on the front and the back of the projector. The remote control must be held at an angle within 30 degrees of the projector's IR remote control sensors to function correctly. The distance between the remote control and the sensors should not exceed 6 meters (19.5 feet).

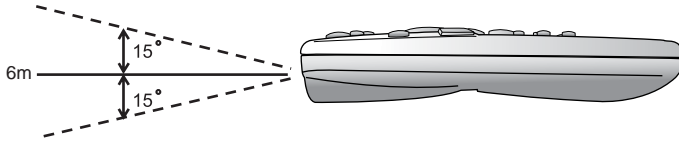

Back view

- ⚠ The laser beam is visible. It is necessary to depress the Laser button for continuous output.
- ⚠ The laser pointer is not a toy. Parents should be mindful of the dangers of laser energy and keep this remote control out of the reach of children.

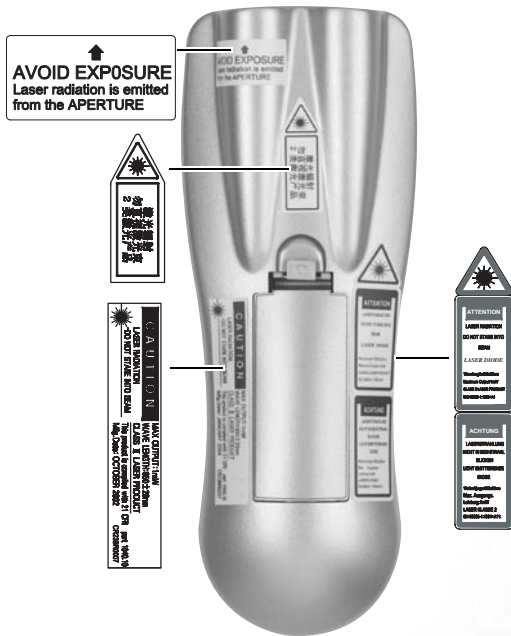

Installing or Replacing the Batteries

1 Push and open the battery compartment lid in the direction shown.

2 Install batteries as indicated by the diagram inside the compartment.

3 Position the lid over the compartment and snap it back into place.

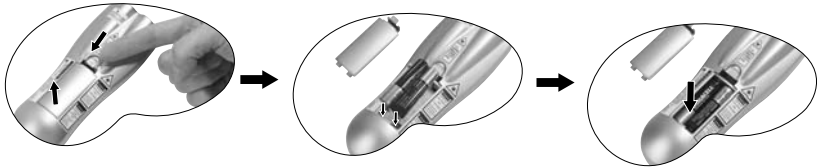

- **Avoid excessive heat and humidity. There may be danger of damage to the remote and injury to those nearby if the batteries are incorrectly replaced.**
- **Replace only with the same or equivalent type recommended by the manufacturer.**
- **Dispose of the used batteries according to the manufacturer's instructions.**
- **Never throw a battery into a fire.**
- **If the batteries are dead or if you will not be using the remote control for a long time, remove the batteries to prevent battery acid from leaking into the battery compartment.**

3 Positioning your projector

Choosing a location

Your projector is designed to be installed in one of four possible installation locations:

1. Floor in front of screen;
2. Ceiling in front of screen;
3. Floor at rear of screen; or
4. Ceiling at rear of screen.

With the use of this wireless projector, there's no need to worry about cable connections. This gives you the flexibility to site the projector anywhere in the room up to a range of 20m away from your laptop, and switch between presentations on different laptops instantly without fiddling with cables.

I. Floor front:

Select this location with the projector placed near the floor in front of the screen. This is the most common way to position the projector for quick setup and portability.

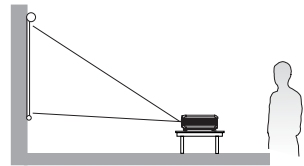

II. Ceiling front:

Select this setting with the projector suspended from the ceiling in front of the screen.

Purchase the BenQ Projector Ceiling Mounting Kit from your dealer to mount your projector on the ceiling.

Set  in the **Source > Mirror** menu after you turn the projector on.

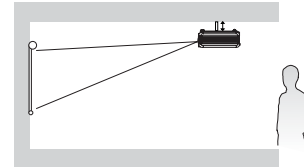

III. Floor rear:

Select this location with the projector placed near the floor behind the screen.

Note that a special rear projection screen is required.

Set  in the **Source > Mirror** menu after you turn the projector on.

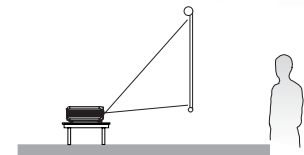

IV. Ceiling rear:

Select this location with the projector suspended from the ceiling behind the screen.

Note that a special rear projection screen and the BenQ Projector Ceiling Mounting Kit are required for this installation location.

Set  in the **Source > Mirror** menu after you turn the projector on.

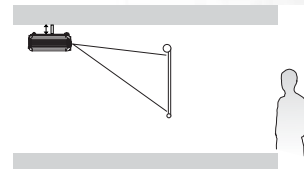

If you place the projector above or below the screen, you have to tilt it down or up to center the image on the screen, in these situations image distortion will occur. Use the Keystone function to correct the distortion. See page 28 for keystone correction.

Obtaining a preferred projected image size

The distance from the projector lens to the screen, the zoom setting, and the video format each factors in the projected image size. BenQ has provided separate tables of dimensions for both 16:9 and 4:3 screen ratios to assist you in determining the ideal location for your projector.

1. Determine the aspect ratio of your screen, (4:3 or 16:9)?
2. Determine the projection distance allowed in your room. Install the projector at a proper distance from the screen.
3. Refer to the table of 4:3 or 16:9 Screen Size according to the screen type you have. Locate the suitable value in the column of “Distance from Screen”. In the same row, you will find the maximum and minimum projected image sizes.
4. Decide the exact height of your projector.

For example, if you are using a 4:3 screen with 2.5 meters projection distance, the maximum image size is close to 1.91 meters diagonal.

If you place the projector above or below the screen, you have to tilt it down or up to center the image on the screen after turning the projector on, in these situations image distortion will occur. Use the Keystone function to correct the distortion. See page 32 for keystone correction.

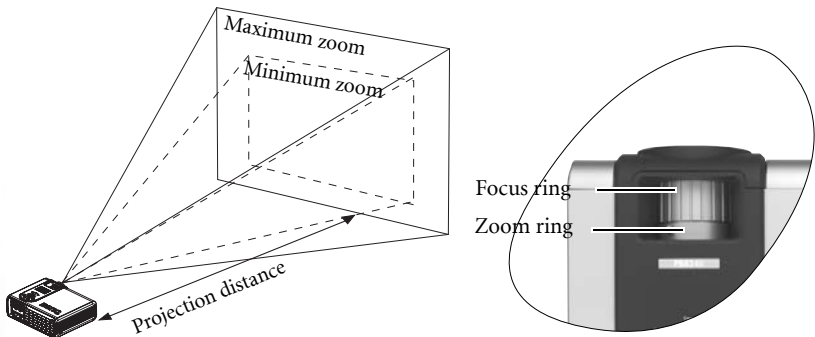

Screen size chart (4:3 aspect ratio)

Distance from screen		Diagonal measurement			
		Minimum zoom		Maximum zoom	
feet	inch	feet	inch	feet	inch
4	48	2.49	29.9	3.05	36.6
6	72	3.73	44.8	4.57	54.9
8	96	4.98	59.7	6.10	73.2
10	120	6.22	74.7	7.62	91.4
12	144	7.47	89.6	9.14	109.7
14	168	8.71	104.5	10.67	128.0
16	192	9.96	119.5	12.19	146.3
18	216	11.20	134.4	13.72	164.6
20	240	12.45	149.4	15.24	182.9
22	264	13.69	164.3	16.76	201.2
24	288	14.94	179.2	18.29	219.5
26	312	16.18	194.2	19.81	237.7
28	336	17.42	209.1	21.34	256.0
30	360	18.67	224.0	22.86	274.3
32	384	19.91	239.0	24.38	292.6
34	408	21.16	253.9	25.91	310.9

Distance from screen		Diagonal measurement			
		Minimum zoom		Maximum zoom	
meter	cm	meter	cm	meter	cm
1	100	0.62	62.2	0.76	76.2
1.5	150	0.93	93.3	1.14	114.3
2	200	1.24	124.5	1.52	152.4
2.5	250	1.56	155.6	1.91	190.5
3	300	1.87	186.7	2.29	228.6
3.5	350	2.18	217.8	2.67	266.7
4	400	2.49	248.9	3.05	304.8
4.5	450	2.80	280.0	3.43	342.9
5	500	3.11	311.2	3.81	381.0
5.5	550	3.42	342.3	4.19	419.1
6	600	3.73	373.4	4.57	457.2
6.5	650	4.04	404.5	4.95	495.3
7	700	4.36	435.6	5.33	533.4
7.5	750	4.67	466.7	5.72	571.5
8	800	4.98	497.8	6.10	609.6
8.5	850	5.40	539.8	6.48	647.7

Screen size chart (16:9 aspect ratio)

Distance from screen		Diagonal measurement			
		Minimum zoom		Maximum zoom	
feet	inch	feet	inch	feet	inch
4	48	2.29	27.5	2.80	33.6
6	72	3.44	41.3	4.20	50.4
8	96	4.59	55.1	5.60	67.2
10	120	5.74	68.8	7.00	84.0
12	144	6.88	82.6	8.40	100.8
14	168	8.03	96.4	9.80	117.6
16	192	9.18	110.1	11.20	134.4
18	216	10.32	123.9	12.60	151.2
20	240	11.47	137.7	14.00	167.9
22	264	12.62	151.4	15.39	184.7
24	288	13.77	165.2	16.79	201.5
26	312	14.91	179.0	18.19	218.3
28	336	16.06	192.7	19.59	235.1
30	360	17.21	206.5	20.99	251.9
32	384	18.35	220.3	22.39	268.7

Distance from screen		Diagonal measurement			
		Minimum zoom		Maximum zoom	
meter	cm	meter	cm	meter	cm
1	100	0.57	57.4	0.70	70.0
1.5	150	0.86	86.0	1.05	105.0
2	200	1.15	114.7	1.40	140.0
2.5	250	1.43	143.4	1.75	179.4
3	300	1.72	172.1	2.10	209.9
3.5	350	2.01	200.8	2.45	244.9
4	400	2.29	229.4	2.80	279.9
4.5	450	2.58	258.1	3.15	314.9
5	500	2.87	286.8	3.50	349.9
5.5	550	3.15	315.5	3.85	384.9
6	600	3.44	344.1	4.20	419.9
6.5	650	3.73	372.8	4.55	454.9
7	700	4.02	401.5	4.90	489.8
7.5	750	4.30	430.2	5.25	524.8
8	800	4.59	458.9	5.60	559.8

 The recommended focus range is from 1.5 ~ 8 meters (6 ~ 32 feet).

There is 3% ~ 5% tolerance among these figures due to optical component variations.

* 1 m = 3.28 feet, 1 foot = 0.305 m, 1 m = 100 cm, 1 foot = 12 inches

4 Connection

Wireless connection

This is the recommended and most convenient way of using this projector. You will need to insert the wireless card to your projector and install the necessary software onto your laptop to enable you to make presentations.

To use the projector without cables:

1. Align the wireless card with the designed slot on the front side of the projector.
2. Insert the wireless card to your projector. The eject button pops out once the card is fully inserted. Make sure the card is securely in place.
3. Install Wireless Navigator with the supplied Wireless Navigator software CD onto your laptop. Refer to the Wireless Navigator User's Manual for installing the software and the subsequent operations on your laptop.
4. To eject the wireless card from the projector, press the eject button below the wireless card slot.

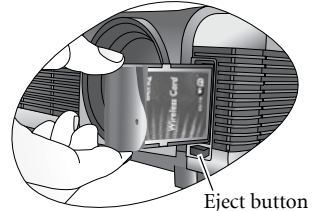

Notes about the wireless card:

- **The wireless card is an IEEE802.11/802.11b compliant CF wireless LAN adaptor. It fully supports wireless networking under Windows 98SE/ME/2000/XP.**
- **The wireless card is only compatible with BenQ PB8260 projector. We do not guarantee it works correctly with other devices.**
- **The effective range of the networking is within 20m indoors.**
- **Do not service the card yourself like revising the software inside.**

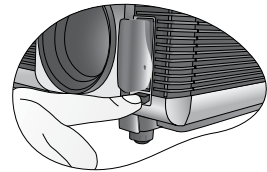

Cable connections

When connecting a signal source to the projector, be sure to:

1. Turn all equipment off before making any connections.
2. Use the correct signal cables for each source.
3. Ensure the cables are firmly inserted.

Connecting to a laptop or desktop computer

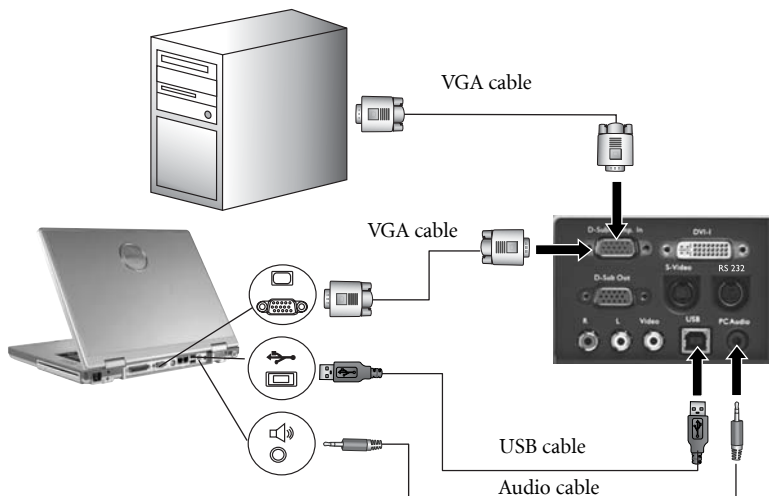

Notes:

- A Mac adaptor (an optional accessory) may be necessary if you are connecting to an older Macintosh computers.
- The USB cable is required if you intend using the mouse functions on the remote control.
- Many laptops do not turn on their external video ports when connected to a projector. Usually a key combo like FN + F3 or CRT/LCD key turns the external display on/off. Locate a function key labeled CRT/LCD or a function key with a monitor symbol on the laptop. Press FN and the labeled function key simultaneously. Refer to your laptop's documentation to learn your laptop's key combination.

Connecting equipment to the component video input

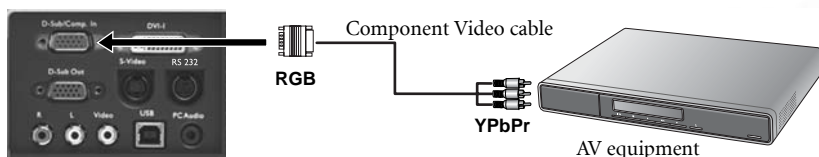

The projector is capable of displaying various High Definition TV display modes. Some of these sources are:

- Digital-VHS (D-VHS) player
- DVD player
- Satellite Dish HDTV receiver
- Digital TV tuners

Most of these sources will provide an analog component video output, a standard VGA output, or a YPbPr (default) format.

The projector is capable of accepting HDTV data through a Component Video connector. Use a Component Video cable that came with your projector to display these images.

The following standards are supported in the HDTV function:

- 480i
- 480p

- 576i
- 720p (50/ 60 Hz)
- 576p
- 1080i (50/ 60 Hz)

Connecting to video or S-Video devices

S-Video devices

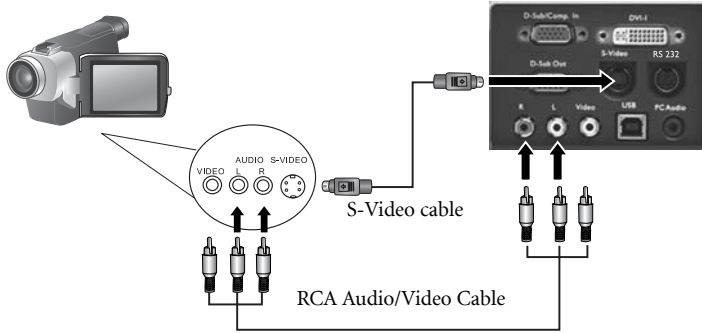

Video devices or VCR

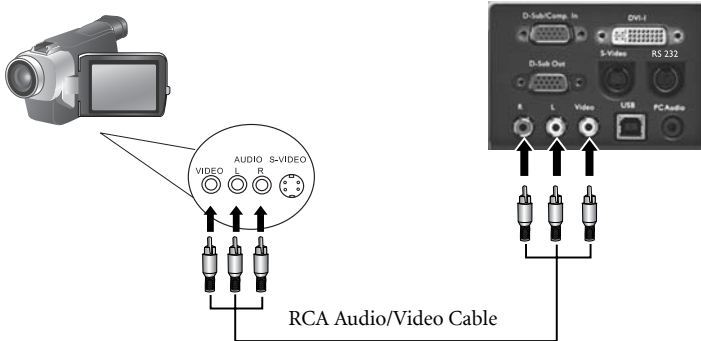

☞ If the selected video image is not displayed after the projector is turned on and the correct video source has been selected, check that the video source is turned on and operating correctly. Also check that the signal cables have been connected correctly.

Connecting to display devices

If you want to monitor your presentation close-up on a monitor as well as on the screen, you can connect the RGB signal output port on the projector to an external monitor with a VGA cable or D-Sub - DVI cable.

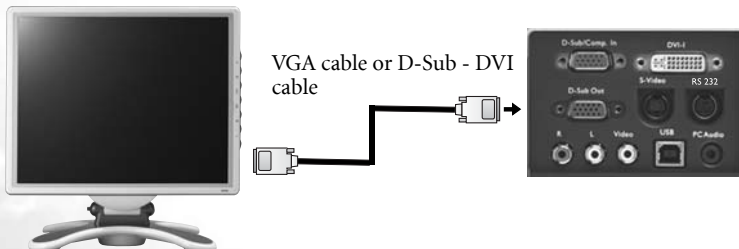

5 Operation

Start up

1. Switch all of the connected equipment on.
2. Plug the power cord into the projector and into a wall socket. Turn on the power point (if switched).

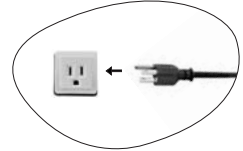

3. Turn the main power switch on. The **Power indicator** lights orange.
4. Remove the lens cap. If it is left on, it could become deformed due to heat.



5. Press and hold (for 2 seconds) the **Power** button on the remote control or projector to start the unit. The **Power indicator light** flashes green when the unit is on.



6. The start up procedure takes about 30 seconds after pressing **Power**. In the later stage of start up, a default BenQ logo is projected.

7. Next, a projector boot screen displays as below. If the supplied BenQ wireless card is installed in the projector and its indicator lights green, set up your laptop or desktop later by using the information shown on the page like Network ID (SSID), Network Type, and IP Address.

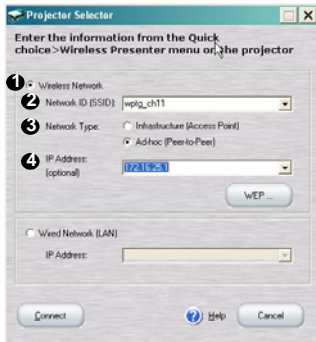

Projector Selector page on your computer



Projector boot screen

8. If you are going to display a image from other signal input, press **Source** on the projector or remote control. The projector screen displays the current input source being scanned at the bottom right corner of the screen. If no input source signal is detected, the search will continue until an input source signal is detected.
9. For more information on source selection, refer to “Switching input signals” section below.

 If the frequency/ resolution of the input signal exceeds the projector’s operating range, you will see the message “Out of Range” displayed on a blank screen.

Preparing for a wireless presentation

1. **Is Wireless Navigator installed on your laptop?**
Yes, go to the next step below.
No, load on your laptop using the Wireless Navigator Installation CD provided. Refer to **Chapter 2: Software Installation and Setup** in the Wireless Navigator user’s manual.
2. **Start the projector with the wireless card inserted (LED up) so you see the projector boot screen.**
3. **Make sure your laptop is enabled with wireless connection.**
4. **Configure the network settings on your laptop. Refer to the Part One: Wireless Configuration of Chapter 3: Making Presentation in the Wireless Navigator user’s manual.**
5. **If the presentation is made by multiple users, refer to Chapter 4: Collaborative Presentation in the Wireless Navigator user’s manual.**
6. **You can also find other relevant information about operating the software in the provided Wireless Navigator user’ manual.**

Switching input signals

To sequentially select input sources, press **Source** on the projector control panel or the remote control. It may take you a few seconds when the projector is searching for input signals. The selected source will be displayed at the bottom right of the screen for 3 seconds.

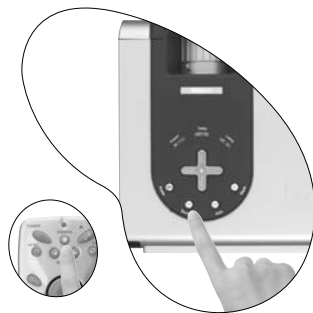

Adjusting the image

Adjusting the height

Place your projector on a flat level surface and ensure that the projector is square to the screen.

The projector is equipped with 2 quick-release adjuster feet. These adjusters change the image height and projection angle. To adjust the projector,

1. Lift the projector up and press the adjuster button to release the adjuster. The adjuster will drop into position and be locked.

 **Do not look into the lens while the lamp is on. The strong light from the lamp may cause damage to your eyes or sight.**

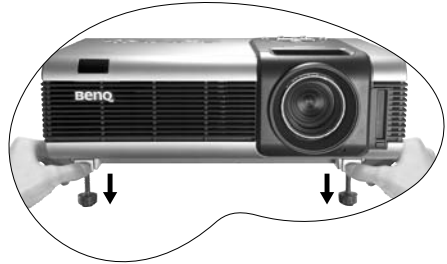

2. Screw the rear adjuster feet to fine-tune the projection angle.

To retract the foot, press the adjuster button again.

 **If the screen and the projector are not perpendicular to each other, the projected image becomes vertically trapezoidal. To correct this situation, adjust the value of Keystone in the Display menu, on the projector control panel or on the remote control.**



Auto-adjusting the image

In some cases, you may need to optimize the picture quality. To do this, press **Auto** on the control panel of the projector or on the remote control. Within 3 seconds, the built-in Intelligent Auto Adjustment function will re-adjust the values of Frequency and Clock to provide the best picture quality.

 **The screen will be blank while Auto is functioning.**



Correcting keystone

Keystoning refers to the situation where the projected image is noticeably wider at either the top or bottom. It occurs when the projector is not perpendicular to the screen.

To correct this, besides adjusting the height of the projector, you will need to manually correct it following ONE of these steps.

A. Press ◀ **Left/ Right** ▶ (hot key) on the control panel of the projector to display the status bar labelled Keystone. Press **Right** ▶ to correct keystoning at the top of the image. Press ◀ **Left** to correct keystoning at the bottom of the image.

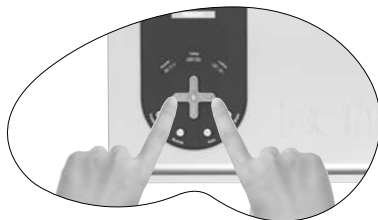

B. Press ◀ **Keystone/ Keystone** ▶ on the remote control to display the status bar labelled Keystone. Press **Keystone** ▶ to correct keystoning at the top of the image. Press ◀ **Keystone** to correct keystoning at the bottom of the image.



C. Press **Menu** key on the projector or the remote control. Go to  **Display** --> **Keystone** and adjust the values by pressing ◀ **Left/ Right** ▶ on the projector or ◀ **Keystone/ Keystone** ▶ on the remote control.

	<ol style="list-style-type: none"> 1. Press Right ▶ on the projector or 2. Press Keystone ▶ on the remote control or 3. Press ▶ Right on the projector or Keystone ▶ on the remote control when you are in Display --> Keystone menu. 	
Keystone 0		Keystone +16
	<ol style="list-style-type: none"> 1. Press ◀ Left on the projector or 2. Press ◀ Keystone on the remote control or 3. Press ◀ Left on the projector or ◀ Keystone on the remote control when you are in Display --> Keystone menu. 	
Keystone 0		Keystone -16

Fine-tuning the image size and clarity

1. Adjust the projected image to the size that you need using the zoom ring.
2. Then sharpen the image by rotating the focus ring.

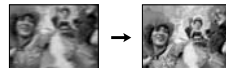

Refer to the screen size tables on page 21.

Zoom In + / Zoom Out -

By pressing **Zoom +**, the center of the picture will be magnified. When the **+** button is pressed again, the picture is further magnified. Use the Mouse Pad to navigate the image. By pressing **Zoom -**, the size of the image is reduced. When the **-** button is pressed again, the picture is further reduced until it is restored to the original size. You can also restore the actual image size by pressing **Return**.



Optimizing the image

Use the remote control or on-screen menus to optimize the image. For the operation of on-screen menus, please refer to page 34.

1. Select a preset mode on the projector, remote control,

or in  **Control** > **Preset Mode**. There are 4 modes available for each input.

PC/ DVI Signal input

- **Presentation Mode:** Is designed for presentations. The brightness is emphasized in this mode.
- **Vivid Mode:** Is perfect for playing games. The color saturation and brightness are well-balanced.
- **Video Mode:** Is suitable for cinematic enjoyment displaying images in their natural color.
- **Economic Mode:** Use this mode to reduce the system noise and reduce the power consumption by 20%. The lamp life is also extended with lower light output.

YPbPr/ YCbCr/ S-Video/ Video Signal Input

- **Gaming Mode:** Is suitable for playing video games in a bright living room.
- **Video Mode:** With a higher color temperature, it is suitable for enjoying TV movies.
- **Cinema Mode:** With a lower color temperature, it is suitable for enjoying cinematic movies.
- **Economic Mode:** Use this mode to reduce the system noise and reduce the power consumption by 20%. The lamp life is also extended with lower light output.

2. You can adjust Brightness and Contrast settings for a DVI-A or DVI-D image

using the  **Display** menu or with the remote control. Alternatively, you can adjust the Brightness, Contrast, Color, and Tint settings whilst viewing a Component Video, Composite Video, or S-Video input.

 **Some picture adjustments are available only when certain input ports are in use. Unavailable adjustments are not shown on the screen. Refer to page 34 for functions available for each signal type.**

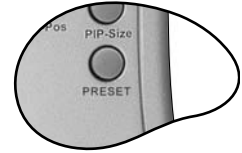

Laser pointer operation

The Laser Pointer is a presentation aid for professionals. It emits red colored light when you press it and the LED indicator lights up green. Do not look into the laser light window or shine the laser light beam on yourself or others. Refer to the warning messages on the back of the remote control and the attached “User Information” prior to using it.



Using the remote mouse functions

Connect the USB port of the projector and the USB port of your PC or laptop with the supplied USB cable prior to using these functions.

The **Mouse Pad** on the remote control can perform the PC or laptop mouse functions. You can move the Mouse Pad in all directions and control the movement of the cursor.



■ When the displayed image is magnified (**+Zoom-**), use the **Mouse Pad** to move around the display areas.

■ The **L-Click** and **R-Click** act as the Left (L) and Right (R) buttons of a computer mouse.

■ To drag and drop objects on the screen,

1. Place the cursor on the object you want to move.
2. Press **Drag**.
3. Move the **Mouse Pad** and drag the object to the destination. Drop the object by pressing **L-Click**.
4. If you want to move a group of objects,
 - i. place the cursor on a proper position. Press **Drag**.
 - ii. Move the **Mouse Pad** over the objects to be selected. Press **L-Click** to release the drag function.
 - iii. Place the cursor on the selected group. Press **Drag** again.
 - iv. Move the **Mouse Pad** and drag the objects to the destination. Drop the object by pressing **L-Click**.

PIP (Picture In Picture) operation

Your projector is capable of displaying images simultaneously from two input sources, which can be used to enhance your presentation in an interesting way.

These functions are available only when the input source is PC and the PIP source is Video or S-Video.



Operation on the remote control

1. Ensure both the PC, and Video or S-Video signals are correctly connected to the projector.
2. Display the PC image on the screen.
3. Press **PIP-Source** on the remote control to display the PIP frame. Press **PIP-Source** a second time and wait for the PIP image for a while until it is displayed.
4. To change the position of the PIP image, press **PIP-Pos** repeatedly until a suitable position is selected.

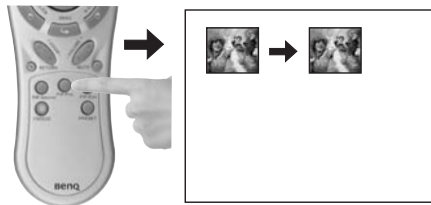

5. To resize the PIP image, press **PIP-Size** repeatedly. There are three options available, small, medium, and large sizes.

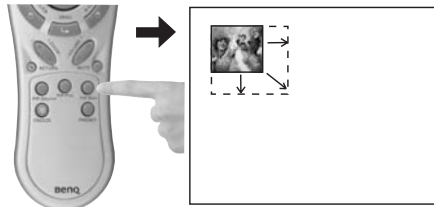

More functions are available in the on-screen menus.

Operation in the on-screen menus

1. Press **Menu** on the projector or remote control.
2. Use **Left/ Right** on the projector or **Keystone/ Keystone** on the remote control to select  **PIP** menu.
3. Refer to page 41 for more information.

Freezing the image

The image is frozen when **Freeze** is pressed. An icon  will appear in the lower right corner of the screen. To release the function, press **Freeze** again, **Return** or **Source** (this will change the input source and release the pause function).

Even if an image is frozen on the screen, the pictures are running on the video or other device. If the connected devices have active audio output, you will still hear the audio even though the image is frozen.

Refer to page 39 for more information.



Adjusting the volume

Adjust the loudness by pressing **Volume + / -**. Or press **Mute** to mute the sound.

To reach a preferred sound quality, you can adjust the treble and bass levels in the  **Source** menu.

 **Ensure the projector is connected to an audio output device with a correct audio cable.**



Hiding the image

In order to draw the audience's full attention to the presenter during a presentation, you can use the **Blank** button to hide the screen image. Press the **Blank** button again to restore the image. A word "**BLANK**" will display at the bottom right corner of the screen when the image is hidden.

Set the duration of blank time in  **Control > Setup > Blank Time** menu.

 **Do not block the projection lens from projecting as this could cause the blocking object to become heated and deformed or even cause a fire.**



Shutdown

1. Press **Power** and a confirmation prompt message displays. To turn the projector off, press **Power** again.
2. The **Power indicator light** flashes orange and the lamp shuts down. The fans will continue to run for approximately 90 seconds to cool down the projector lamp.

 **To protect the lamp, the projector will not respond to any commands during the cooling process.**

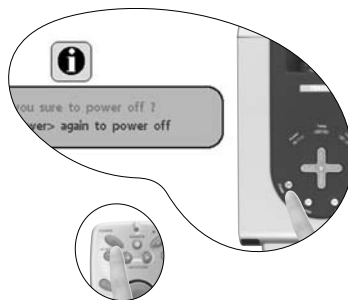

3. Turn the main power switch off.







 **Note:**

- Do not unplug the power cord before the projector shutdown sequence is complete or during the 90-second cooling down process.
- If the projector is not properly shut down, to protect the lamp, when you attempt to restart the projector within minutes, the fans will run for a few minutes to cool down. Press Power again to start the projector after the fans stop.

Menu operation

Menu System

The OSD menus will vary according to the selected signal type.

Functions available when receiving different signal types...				
Sub-Menu	Analog RGB / DVI-A	DVI-D / Wireless	YPbPr (480p/ 576p/ 720p/ 1080i)	YCbCr (480i/ 576i) / S-Video / Video
 Display	Keystone Brightness Contrast Phase H Size Lamp Hour	Keystone Brightness Contrast Lamp Hour	Keystone Brightness Contrast Phase H Size Lamp Hour	Keystone Brightness Contrast Color Tint Lamp Hour
 Image	Auto Resize H Position V Position Color Temp Information	Auto Resize Color Temp Information	Ratio H Position V Position Color Tint Color Temp	Ratio System Sharpness Color Temp Information
 Source	Mirror Source Volume Treble Bass Mute			
 Control	Language OSD -- OSD Pos., OSD Time Setup -- Source Scan, Keystone Hold, Mirror Hold, Blank Time, Auto Off, User Logo Economic Mode Preset Mode -- (PC/ DVI/ Wireless signal input) Presentation Mode, Vivid Mode, Video Mode, Economic Mode (YPbPr/ YCbCr/ S-Video/ Video signal input) Gaming Mode, Video Mode, Cinema Mode, Economic Mode Reset High Altitude			
 PIP	Main Page: PIP Source PIP Size PIP Pos. H Position V Position More Options		Sub Page: Brightness Contrast Color Tint Sharpness System	

Using the menus

The projector is equipped with on-screen display (OSD) menus for making various adjustments and settings.

There are 10 different menu languages. (Refer to page 39 for more details.)

The following example describes the adjustment of the keystone.

1. Press **Menu** on the projector or remote control to turn the on-screen menu on.

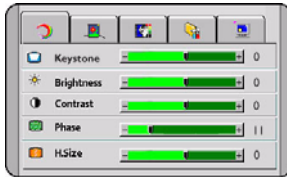

4. Adjust keystone values by pressing **Left/ Right** on the projector or **Keystone/ Keystone** on the remote control.



2. Use **Left/ Right** on the projector or **Keystone/ Keystone** on the remote control to select **Display** menu.
3. Use **Exit** or **Menu** on the projector or **Down/ Menu** on the remote control to select **Keystone**.





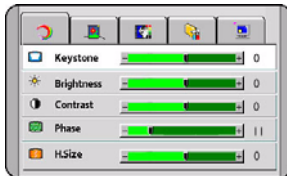

5. Press **Exit** on the projector or press **Exit** twice* on the remote control to leave and save the settings.

*The first press leads you back to the submenu and the second press closes the on-screen menu.









1. Display menu

 Some picture adjustments are available only when certain input ports are in use. Unavailable adjustments are not shown on the screen.

FUNCTION	DESCRIPTION
Keystone	Corrects any keystoneing of the image. Refer to page 32 for more information.
Brightness	<p>Adjusts the brightness of the image. The higher the value, the brighter the image. And lower the setting, darker the image. Adjust this control so the black areas of the image appear just as black and that detail in the dark areas is visible.</p> <div style="display: flex; justify-content: space-around; align-items: center;"> <div style="text-align: center;">  <p>-25</p> </div> <div style="text-align: center;">  <p>0</p> </div> <div style="text-align: center;">  <p>+25</p> </div> </div>
Contrast	<p>Adjusts the degree of difference between dark and light in the image. The higher the value, the greater the contrast.</p> <div style="display: flex; justify-content: space-around; align-items: center;"> <div style="text-align: center;">  <p>-25</p> </div> <div style="text-align: center;">  <p>0</p> </div> <div style="text-align: center;">  <p>+25</p> </div> </div>
Phase	<p>This function allows you to adjust the clock phase to reduce image distortion.</p> <div style="text-align: right;">  </div>
H Size	Adjusts the horizontal width of the image.
Lamp Hour	Displays the number of hours the lamp has been used.
Color	Increases or decreases the color intensity of the image.
Tint	Adjusts the color tones of the image. The higher the value, the more reddish the image becomes. The lower the value, the more greenish the image becomes.

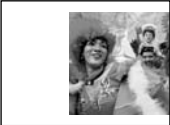
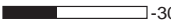
2. Image menu

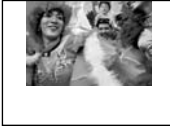



 Some picture adjustments are available only when certain input ports are in use. Unavailable adjustments are not shown on the screen.

FUNCTION	DESCRIPTION
Auto Resize	Makes the best fit of the image to the screen. 1. On 2. Off 3. 16:9
H Position	Adjusts the horizontal position of the projected image. <div style="display: flex; justify-content: space-around; align-items: center; margin-top: 10px;">   </div> <div style="display: flex; justify-content: space-around; align-items: center; margin-top: 5px;"> <div style="text-align: center;">  -30 </div> <div style="text-align: center;">  +30 </div> </div>
V Position	Adjusts the vertical position of the projected image. <div style="display: flex; justify-content: space-around; align-items: center; margin-top: 10px;">   </div> <div style="display: flex; justify-content: space-around; align-items: center; margin-top: 5px;"> <div style="text-align: center;">  -30 </div> <div style="text-align: center;">  +30 </div> </div>
Color Temp	Adjusts the white color. The higher the value, the more reddish white the image becomes. The lower the value, the more bluish white the image becomes.*
Information	Shows the current image resolution.
Ratio	Users have 2 options for the image ratio. 1. 4 : 3 2. 16 : 9
Color	Increases or decreases the color intensity of the image.
Tint	Adjusts the color tones of the image. The higher the value, the more reddish the image becomes. The lower the value, the more greenish the image becomes.
System	Shows the Video input system format, 1.NTSC 2. PAL 3.SECAM 4. YUV.
Sharpness	Adjusts the image to make it look sharper or softer.

***About color temperatures:**

There are many different shades that are considered to be “white” for various purposes. One of the common methods of representing white color is known as the “color temperature”. A white color with a low color temperature appears to be reddish white. A white color with a high color temperature appears to have more blue in it.

3. Source menu

FUNCTION	DESCRIPTION
Mirror	The projector can be installed on a ceiling or behind a screen, or with one or more mirrors. Contact your dealer for the ceiling mount bracket (optional accessory) if you need to install the projector on your ceiling. For more information, refer to page 19.
Source	Shows the current signal source.
Volume	Adjusts the volume level. 
Treble	Adjusts the treble level. (-5 ~ 5) 
Bass	Adjusts the bass level. (-5 ~ 5) 
Mute	<div style="display: flex; justify-content: space-around; align-items: center;"> <div style="text-align: center;"> <p>Off</p>  </div> <div style="text-align: center;"> <p>On</p>  </div> </div>

4. Control menu

FUNCTION	DESCRIPTION
Language	<p>Language sets the language for the OSD control menus.</p> <p>Use the ◀ / ▶ key to select the desired language from among English, French, German, Italian, Spanish, Russian, Traditional Chinese, Simplified Chinese, Japanese and Korean.</p>
OSD	<p>OSD Pos. Selects a desired OSD position.</p>
	<p>OSD Time Sets the length of time the OSD will remain active after your last button press. The range is from 5 to 60 seconds.</p>
Setup	<p>Source Scan Sets whether the projector searches automatically for input signals. If the source scan is on, the projector will search for input signals until it acquires a signal. If the function is not activated, the projector selects the last input signal.</p>
	<p>Keystone Hold When selected, preserves the last keystone correction value even when the projector is restarted.</p>
	<p>Mirror Hold When selected, preserves the last mirror correction value even when the projector is restarted.</p>
	<p>Blank Time Determines the length of time before the projector will automatically shutdown when Blank is activated.</p>
	<p>Auto Off Sets the length of time before the projector will automatically shutdown when there is no input signal detected.</p>
	<p>User Logo Enables the user to select which logo screen will appear during projector start-up. Three modes are available: Default (BenQ logo), black screen or blue screen.</p>
Preset Mode	<p>Preset modes are provided so you can optimize your projector image set-up to suit your program type.</p> <p>For more information, refer to page 29.</p>
Reset	<p>Returns all settings to the factory preset values.</p>

High Altitude

A mode for extreme environments like high altitude and high temperature. We recommend you use the High Altitude mode when your environment is higher than 3000 feet above sea level, or is hotter than 40°C.

Operation under "High Altitude Mode" may cause a higher decibel operating noise level because of increased fan speed necessary to improve overall system cooling and performance.

If you use this projector under other extreme environments excluding the above, it may display auto shut-down symptoms, which is designed to protect your BenQ projector from over-heating. In cases like this, you should switch to High Altitude mode to solve these symptoms. However, this is not to state that this projector can operate under any and all harsh or extreme environments.

5. PIP (Picture In Picture) menu

Your projector is capable of displaying images simultaneously from two input sources, which can be used to enhance your presentation in an interesting way.

These functions are available only when the input source is PC and the PIP source is Video or S-Video.

FUNCTION	DESCRIPTION
PIP Source	Selects the source for the PIP image. Auto is the recommended PIP source as the projector will search for a suitable signal automatically.
PIP Size	Press the ◀ / ▶ keys to scroll through the four alternatives: Off, Small, Medium, Large. Selecting Off closes the PIP image.  When the resolution of the PC signal is 1280 x 1024 (SXGA), the selected Large PIP size will be reduced to the Medium size.
PIP Position	Selects a desired position for the PIP.
H Position	Adjusts the horizontal position of the PIP image.
V Position	Adjusts the vertical position of the PIP image.
More Options	Press the ◀ / ▶ keys to select more PIP functions including Brightness, Contrast, Color, Tint, Sharpness and System.
Brightness	Adjusts the brightness of the PIP image.
Contrast	Adjusts the degree of difference between dark and light in the PIP image. The higher the value, the greater the contrast.
Color	Increases or decreases the color intensity of the PIP image.
Tint	Adjusts the color tones of the PIP image. The higher the value, the more reddish the image becomes. The lower the value, the more greenish the image becomes.
Sharpness	Adjusts the image to make it appear sharper or softer
System	Shows Video input system format, NTSC, PAL, SECAM or YUV.

6 Maintenance

Your projector needs little maintenance. The only things you have to do on a regular basis are to keep the lens clean and to clean the dust filters to prevent overheating.

Never remove any parts of the projector except the lamp and dust filters. Contact your dealer if other parts need replacing.

Cleaning the lens

Clean the lens whenever you notice dirt or dust on the surface.

- Use a canister of compressed air to remove dust.
- If there is dirt or smears, use lens-cleaning paper or moisten a soft cloth with lens cleaner to gently wipe the lens surface.

☞ **Never rub the lens with abrasive materials.**

Cleaning the projector case

Before you clean the case, turn the projector off and unplug the power cord.

- To remove dirt or dust, wipe the case with a soft, dry, lint-free cloth.
- To remove stubborn dirt or stains, moisten a soft cloth with water and a neutral detergent. Then wipe the case.

☞ **Never use wax, alcohol, benzene, thinner or other chemical detergents. These can damage the case.**

Cleaning and replacing the dust filters

It is necessary to clean the dust filters periodically. If the filters are not cleaned, they can become clogged with dust and prevent proper ventilation. This can cause overheating and a malfunction of the projector.

A warning message like the one pictured to the right will be displayed for 10 seconds every 300 hours to remind you to clean the filters.

1. Turn the project off and wait until the fans stop running.
2. Disconnect the projector from any cables.
3. Open one dust filter cover from the right and another one from the front of the projector.



Please check if the filter is clean. Please clean the filter by using a small vacuum or brush if filter is dirty. Press "Exit" to confirm.

From the front side:

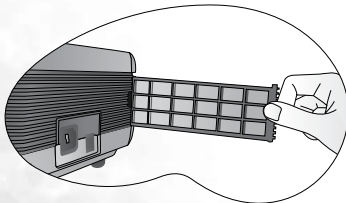

From the right side:

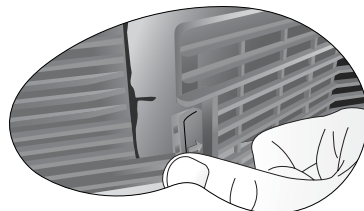

4. Use a small vacuum cleaner designed for computers and other office equipment to clean the filters. Or use a soft brush (such as a clean artist's paintbrush) to gently sweep the dust away.

If the dirt is difficult to remove or the filters are broken, replace them. Contact your dealer or visit BenQ website at www.BenQ.com for more service information.

5. Replace the filters then press the covers back until they click into place.

If the covers are not correctly seated in place, you will be reminded by a message displayed on the screen every three minutes. The projector will automatically shut down after 10 minutes if there has been no further action taken. Re-install the filters securely, then turn on the power again.

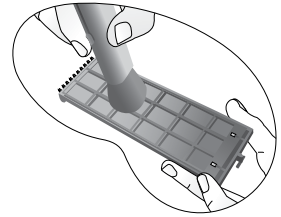

Please check
Filter not well attached

Storing the projector

If you need to store the projector for an extended time, please follow the instructions below.

- Make sure the temperature and humidity of the storage area are within the recommended range for the projector. Please refer to the Spec. page (51) in the manual or consult your dealer about the range.
- Retract the adjuster feet.
- Remove the batteries from the remote control.
- Pack the projector in its original packing or equivalent.

Transporting the projector

It is recommended that you ship the projector with its original packing or equivalent. When you carry the projector yourself, please use the provided soft carry case.

Lamp information



Use and replacement of the lamp

When the **Lamp Indicator** lights up red or a message appears suggesting it is time to replace the lamp, please install a new lamp. An old lamp may cause a malfunction in the projector and in some instances the lamp may explode.

For more detailed information on the warning indicators, please refer to page 46.

 **The Lamp indicator light and Temperature warning light will light up if the lamp becomes too hot. Turn the power off, allow the projector to cool down before checking that the dust filters are not clogged (page 42). If the Lamp or Temp indicator still lights up after turning the power back on, please contact your dealer.**

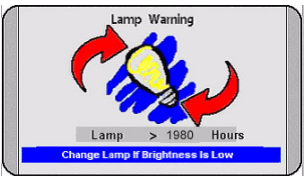
The following Lamp warning displays will remind you of the lamp condition.

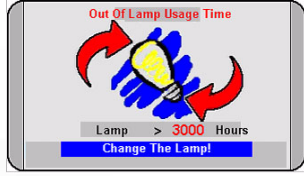
Message	Status
	<p>The lamp has been in operation for 1980 hours. Install a new lamp for optimal performance. If the projector is normally run with Preset "Economic Mode" selected (page 39), you may continue to operate the projector until the 2980 hour lamp warning appears.</p>
	<p>The lamp has been in operation for 2980 hours, the power will shutdown in 20 hours time. A new lamp should be fitted to avoid the inconvenience when the projector runs out of lamp time.</p>
	<p>The lamp has been in operation for over 3000 hours. This message will flash in the center of the screen together with the Lamp indicator lighting up red for 40 seconds. The projector will shutdown after 40 seconds. The lamp MUST be replaced before the projector will operate normally.</p>

Lamp replacement

-  • To reduce the risk of electrical shock, always turn the projector off and disconnect the power cord before changing the lamp.
- To reduce the risk of severe burns, allow the projector to cool for at least 45 minutes before replacing the lamp.
- To reduce the risk of injuries to fingers and damage to internal components, use caution when removing lamp glass that has shattered into sharp pieces.
- To reduce the risk of injuries to fingers and/or compromising image quality by touching the lens, do not touch the empty lamp compartment when the lamp is removed.

- **This lamp contains mercury. Consult your local hazardous waste regulations and dispose of this lamp in the proper manner.**

- Step 1. Turn the power off and disconnect the projector from the wall socket.
- Step 2. Protect the projector's surface by clearing a flat open area on your desk and placing a soft item on the desk for padding.
- Step 3. Turn the projector over. Then loosen the screws and remove the lamp cover. If the lamp is hot, avoid burns by waiting for 45 minutes until the lamp has cooled.

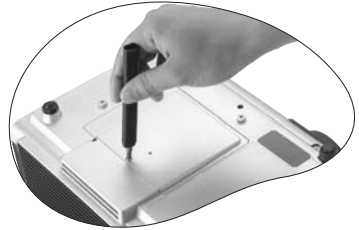

- Step 4. Loosen the screw that fixes the lamp to the projector. If the screw is not loosened completely, the lamp cannot be removed. Be careful not to lose the screw as it is needed to hold the replacement lamp in place. It is strongly recommended that you use a magnetic-head screwdriver.

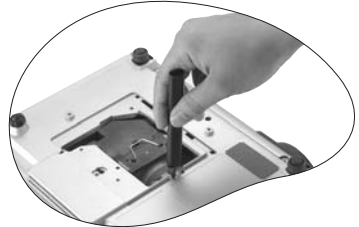

- Step 5. Lift the handle so that it stands up. Use the handle to slowly pull the lamp out of the projector.



- **Pulling too quickly may cause the lamp to break and scatter broken glass in the projector.**
- **Do not place the lamp in locations where water might splash on it, children can reach it, or near flammable materials.**
- **Do not insert your hands into the projector after the lamp is removed. If you touch the optical components inside, it could cause color unevenness and distortion of the projected images.**

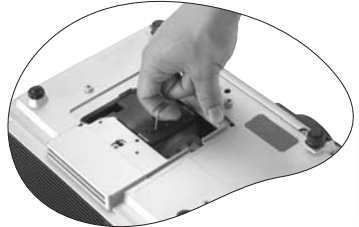

- Step 6. Insert the new lamp. Ensure the handle is fully laid flat and locked in place. Reinsert and tighten the screw firmly.



- **A Loose screw may cause a bad connection, which could result in malfunction.**
- **Do not over tighten the screw.**

- Step 7. Re-install the lamp cover and tighten the screws.

- Step 8. Make connection to a signal source to be displayed. Start up the projector. (Refer to page 22 for making connection and page 25 for turning the power on.)



- **Do not turn the power on with the lamp cover removed. Whenever the lamp is replaced, reset the total lamp operation timer.**



- **Do not reset if the lamp is not replaced as this could cause damage.**

Step 9. **Reset the lamp counter**

1. Press and hold **Exit** on the projector for 3 seconds to display the total used lamp time.
2. Press **Menu** on the projector or on the remote control to access the lamp hour timer. An adjustment message will appear.
3. Press **◀** or **▶** to reset lamp hours and press **EXIT** to leave.



Temperature warning light

When the Temperature warning light is on, it is warning you of the following possible problems:



1. The internal temperature is too high.
2. Dust filters are clogged.
3. The fans are not working.

Turn the projector off, check that the dust filters are clean. If the problem persists, contact qualified service personnel for further help.

















For more detailed information, please refer to the following section.

Indicators

Illustration - table legend.

1. Blank - : Light OFF
2.  : Light flashing
3.  : Light ON
4. **O** : Orange light
5. **R** : Red light
6. **G** : Green light

LED			Status & Description
Power	Temp	Lamp	
Power events			
			The projector has just been connected to a power outlet.
	-	-	Stand-by mode.
	-	-	(1) The projector needs 90 seconds to cool down as it was abnormally shut down without the normal cooling down process. Or (2) The projector needs to cool for 90 seconds after the power is turned off.
	-	-	The Power indicator light is flashing during powering up.
	-	-	The projector is under normal operation.
Lamp events			
-	-	-	The lamp counter has developed a problem.
-	-		It is warning you that lamp usage has exceeded 3000 hours. Replace the projection lamp with a new one immediately.
-	-		The lamp is not properly attached or the lamp is damaged. Please contact your dealer for assistance.
Thermal events			
-		-	The projector has shutdown automatically. If you try to restart the projector, it will shutdown again. Please contact your dealer for assistance.
-			The projector has shutdown automatically. If you try to restart the projector, it will shutdown again. Please contact your dealer for assistance.
-			The projector has shutdown automatically. If you try to restart the projector, it will shutdown again. Please contact your dealer for assistance.
		-	The projector has shutdown automatically. If you try to restart the projector, it will shutdown again. Please contact your dealer for assistance.

			The projector has shutdown automatically. If you try to restart the projector, it will shutdown again. Please contact your dealer for assistance.
			The projector has shutdown automatically. If you try to restart the projector, it will shutdown again. Please contact your dealer for assistance.
		-	The projector has shutdown automatically. If you try to restart the projector, it will shutdown again. Please contact your dealer for assistance.
			The projector has shutdown automatically. If you try to restart the projector, it will shutdown again. Please contact your dealer for assistance.
			The projector has shutdown automatically. If you try to restart the projector, it will shutdown again. Please contact your dealer for assistance.
			The projector has shutdown automatically. If you try to restart the projector, it will shutdown again. Please contact your dealer for assistance.

Service information

Accessories (included in the standard package)

Description	Part Number
Power cord (US)	27.01818.000
Power cord (EU)	27.82718.281
Power cord (UK)	27.01018.000
VGA cable	50.J0508.503
PC audio cable	50.L4302.501
Soft carry case	47.J8104.001
VGA-Component cable	50.J2401.001
USB cable	50.73213.501
Remote control	56.26J95.001
VGA - DVI cable	50.J2103.501
RCA Audio/Video cable	50.72918.001

Optional accessories (not included in the standard package)

Description of parts	Part number
Mac adaptor (switchable)	20.20118.A15
300W lamp module	60.J8106.001
250W lamp module	59.J9421.CG1
Ceiling mount kit	60.J7683.001
Wireless Pro (EU)	59.J8201.001
Wireless Pro (US)	59.J8201.002
Presentation Pro	60.J2278.001
DVI-I cable	50.J2508.501
S-Video cable	50.72920.011
Dust filter	60.J8178.001
3-2 power converter	22.91007.001

Ordering parts or getting information

For product information, product assistance, service information, or to order accessories, please visit the BenQ Corporation website at <http://www.BenQ.com>.

7 Troubleshooting

Common problems & solutions

? THE PROJECTOR DOES NOT TURN ON.

Cause	Remedy
There is no power from the power cable.	Plug the power cord into the AC inlet on the projector, and plug the power cord into the power outlet. If the power outlet has a switch, make sure that it is switched on.
Attempting to turn the projector on again during the cooling process.	Wait until the cooling down process has completed.

? NO PICTURE

Cause	Remedy
The video source is not turned on or connected correctly.	Turn the video source on and check that the signal cable is connected correctly.
The projector is not correctly connected to the input source device.	Check the connection.
The input signal has not been correctly selected.	Select the correct input signal with the Source key on the projector or remote control.
The lens cap is still attached to the lens.	Remove the lens cap.

? BLURRED IMAGE

Cause	Remedy
The projection lens is not correctly focused.	Adjust the focus of the lens using the focus ring.
The projector and the screen are not aligned properly.	Adjust the projection angle and direction as well as the height of the unit if necessary.
The lens cap is still attached to the lens	Remove the lens cap.

? REMOTE CONTROL DOES NOT WORK

Cause	Remedy
The batteries are out of power.	Replace both of the batteries with new ones.
There is an obstacle between the remote control and the projector.	Remove the obstacle.
You are too far away from the projector.	Stand within 6 meters (19.5 feet) of the projector.

8 Specifications

Projector specifications

Technical specifications

 All specifications are subject to change without notice.

General

Product name	Digital Projector
Model name	PB8260 1024 x 768 XGA

Optical

Display system	1-CHIP DMD
Lens F/Number	F/2.4
Lamp	PB8260 300W lamp

Electrical

Power supply	AC100 ~ 240V, 4.5A, 50/60 Hz (Automatic)
Power consumption	PB8260 410W (Max)

Mechanical

Dimensions	320 mm (W) x 106 mm (H) x 236 mm (D)
Weight	8.4 lbs (3.8 Kg)

Input terminal

Computer input	
RGB input	D-sub 15-pin (female)
DVI-I input	
Video signal input	
S-VIDEO	Mini DIN 4-pin port x 1
VIDEO	RCA x 1
HDTV signal input	D-sub <--> YPbPr RCA jack x 3, through RGB input
Audio signal input	
Audio 1	Mini stereo socket

Output

USB mouse connector	A/B series x 1
Speaker	2 watt x 2
RGB	
Audio L/R	

Control

RS-232C	9-pin x 1
---------	-----------

Environmental Requirements

Operating temperature	0°C ~ 40°C at sea level
Operating relative humidity	10% ~ 90% (without condensation)
Operating altitude	1830 meters (6000 feet) at 30°C
	1830 ~ 3050 meters (6000 ~ 10000 feet) at 23°C

Dimensions

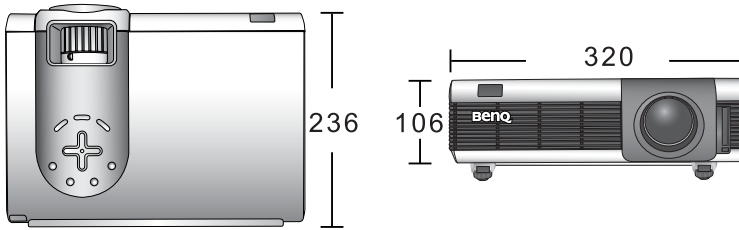

Unit: mm

Timing chart

Supported timing for PC (including DVI-I and Wireless) input

Resolution	Horizontal Frequency (kHz)	Vertical Frequency (Hz)	Pixel Frequency (MHz)	Mode
720 x 400	37.927	85.039	35.500	720 x 400_85
640 x 480	31.469	59.940	25.175	VGA_60
	37.861	72.809	31.500	VGA_72
	37.500	75.000	31.500	VGA_75
	43.269	85.008	36.000	VGA_85
800 x 600	37.879	60.317	40.000	SVGA_60
	48.077	72.188	50.000	SVGA_72
	46.875	75.000	49.500	SVGA_75
	53.674	85.061	56.250	SVGA_85
*1024 x 768	48.363	60.004	65.000	XGA_60
1024 x 768	56.476	70.069	75.000	XGA_70
	60.023	75.029	78.750	XGA_75
	68.667	84.997	94.500	XGA_85
1280 x 1024	63.981	60.020	108.000	SXGA3_60

 * The only mode supports wireless input.

- To achieve the best quality projected image, please use the projector's native resolution of 1024 x 768.

Supported timing for YPbPr input

Signal Format	Horizontal Frequency (kHz)	Vertical Frequency (Hz)
480i(525i)@60Hz	15.73	59.94
480p(525p)@60Hz	31.47	59.94
576i(625i)@50Hz	15.63	50.00
576p(625p)@50Hz	31.25	50.00
720p(750p)@60Hz	45.00	60.00
720p(750p)@50Hz	37.50	50.00
1080i(1125i)@60Hz	33.75	60.00
1080i(1125i)@50Hz	28.13	50.00

Supported timing for Video and S-Video inputs

Video mode	Horizontal Frequency (kHz)	Vertical Frequency (Hz)	Color Sub-carrier Frequency (MHz)
NTSC	15.73	60	3.58
PAL	15.63	50	4.43
SECAM	15.63	50	4.25 or 4.41
PAL-M	15.73	60	3.58
PAL-N	15.63	50	3.58
PAL-60	15.73	60	4.43
NTSC4.43	15.73	60	4.43

Warranty

Limited warranty

BenQ warrants this product against any defects in material and workmanship, under normal usage and storage.

Proof of purchase date will be required with any warranty claim. In the event this product is found to be defective within the warranty period, BenQ's only obligation and your exclusive remedy shall be replacement of any defective parts (labor included). To obtain warranty service, immediately notify the dealer from which you purchased the product of any defects.

Important: The above warranty shall be void if the customer fails to operate the product in accordance with BenQ's written instructions, especially the ambient humidity must be in-between 10% and 90%, temperature in-between 0°C and 40°C, altitude lower than 10000 feet, and avoiding to operate the projector in a dusty environment. This warranty gives you specific legal rights, and you may have other rights which vary from country to country.

For other information, please refer to BenQ Warranty Information Book.

10 Regulatory statements

FCC statement

CLASS B: This equipment generates, uses and can radiate radio frequency energy and, if not installed and used in accordance with the instructions, may cause harmful interference to radio communications. However, there is no guarantee that interference will not occur in a particular installation. If this equipment does cause harmful interference to radio or television reception, which can be determined by turning the equipment off and on, the user is encouraged to try to correct the interference by one or more of the following measures:

- Reorient or relocate the receiving antenna.
- Increase the distance between the equipment and receiver.
- Connect the equipment into an outlet on a circuit different from that to which the receiver is connected.
- Consult the dealer or an experienced radio/TV technician for help.

EEC statement

This machine was tested against the 89/336/EEC (European Economic Community) for EMC (Electric Magnetic Compatibility) and fulfills these requirements.

MIC statement

B class equipment (Household purpose info/telecommunications equipment)

As this equipment has undergone EMC registration for household purpose, this product can be used in any area including residential area.